



Mercedes-Benz W205 NTG 5.0/5.1

Model: MB-NTG5

Specification & Installation



Please contact Tech support at 844-333-3903 or email us at info@emeraldintegrations.com with any questions or concerns about installation.

FOR BEST RESULTS, PLEASE CONTACT US WHILE YOU STILL HAVE ACCESS TO THE CONNECTIONS



Warning

- When installing the main unit, do not remove or alter existing vehicle fasteners, including nuts, bolts, screw, clips, and fittings. Never detach, move or alter existing vehicle wiring, including electrical grounds and straps. Alteration of existing vehicle components may make vehicle unsafe to operate. Should be no any electronic devices or magnetic pole around installation place.
- Air bags are vital part of a safety system. Never install main unit in a way which will alter air bag wiring or interfere with air bag deployment. Air bags must function properly in the event of an accident.
- Before installing, check the location of pipe, tank, electrical cables and others.
- Read and follow the instruction manual.
- Wiring location must not interfere driving, get in or out from car.
- Use electrical tape to insulate the ends of all wires, even if they are not used. Proper insulation prevents arcs, shocks and fires.
- When installation is complete, test all vehicle electrical systems to ensure they operate correctly, including lights, horn, brake lights, and emergency flashers.
- According to our sales policy, any problems caused by user's mistake, careless can not be guaranteed.



Caution

- All steps of installation should be done by well-trained specialist.
- During installation ignition key should be taken off and after all installation finish connect power cable with interface for the last step.
- Do not install the main unit in places where it ma be exposed to dew condensation (around the air conditioning hose, etc), or in locations where it may come in contact with water, high levels of moisture, dust or oily smoke
- Install wiring in a manner in which cables will not come in contact with metal parts. The wiring may be damaged by contact with metal parts, resulting in fire and shocks. Avoid all contact with hot surfaces when wiring the main unit. High temperatures may damage wiring, causing shorts, arcing and fires.
- Kindly check all parts are in the box, when receiving the product, if anything missing, inform to the supplier or manufacturer.

Mercedes-Benz Interface Module Installation - Part 1



Wiring diagram:

Disconnect the factory LVDS cable from the back of the HEAD UNIT, not the screen. This is typically a GREY or PINK LVDS Cable.

Note: Please make sure to have the IGNITION off and NOT in ACC mode during the installation.

If in reverse, the screen is BLACK, please turn ON or DOWN DIP 4 to correlate with the screen resolution.

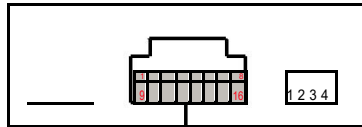

9	Signal GND	Signal GND	1
10	Rearview Video Input	Front-view Video Input	2
11	Camera Power Supply (5V)	Camera Power Supply(5V)	3
12			4
13	IR Signal Output	Reverse Detection Input	5
14	Power GND	Right Turn Signal Output	6
15	CAM Power Supply (12V)	Left Turn Signal Output	7
16	+B Output	ACC Output	8

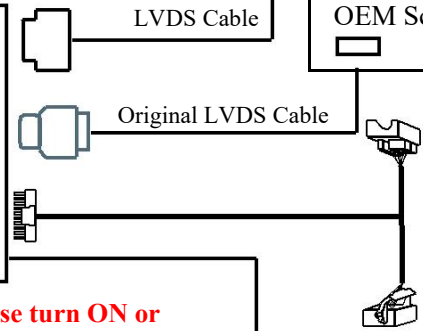
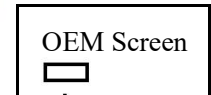
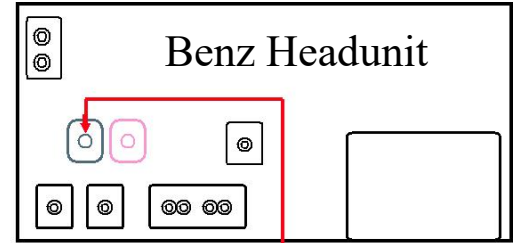
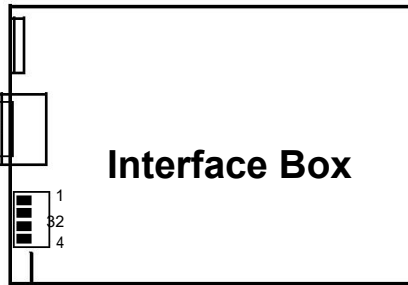

DIP	options		DIP	options	
Sw1 Car model	OFF	2015 C200(w205)/ C260L/ C300/ GLE 250 (AUDIO 20)	Sw3 D V R	OFF	Disable
	ON	2015 B200/ CLA117/ CLA200/ CLS260/ CLS320/ E180L/ E200/ E260/ E400		ON	Enable (Long press 'RETRUN' on steering wheel), if SW2=ON, front view input comes first
Sw2 Front view input	OFF	Disable	Sw4 Resolution	OFF	7.4 inch - 800*480
	ON	Enable (Auto-switch)		ON	8.4 inch - 960*480 (C260L 8.4inch)

1	GND	Power Ground
2	CAN-L	CAN-L
3	CAN- H	CAN-H
4	ACC	ACC Power Input(12V)

Mercedes-Benz Interface Module Installation - Part 2

Notice:

1. Make sure the key is not in the ignition and the vehicle is NOT in ACC mode during installation.
2. Please make sure this interface matches your car model.



1. Using trim removing tools, disconnect the main unit.



2. Remove the screws as shown above.



3. Remove the Command System from the center console to access the LVDS and Quadlock connections.



4. Unplug the OEM Quadlock from the back of the command system.

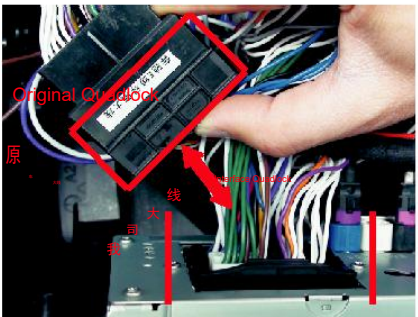

5. Connect the provided Quadlock connector into the OEM port. Using the female end, connect the OEM Quadlock to close off the loop.



6. Unplug the OEM LVDS cable from the back of the head unit and connect it into the interface module as shown above.

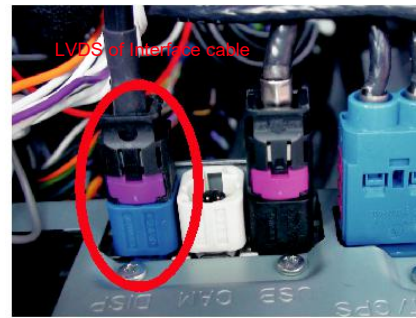

7. Using the provided LVDS cable, connect the module back into the original LVDS port as shown above.

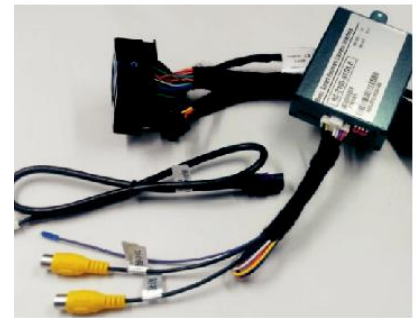

8. Connect the AV harness into the module. Using the labeled inputs, connect rear camera input into REAR CAM IN and front camera into FRONT CAM VIDEO IN (Sold Separately)

Customer Service



At Emerald we want to make sure that you are completely satisfied, therefore we have assembled qualified associates to assist you.

Our normal operating hours are **Monday - Thursday 9:00 AM - 5:00 PM and Friday 9:00 AM - 4:00 PM (Pacific Standard Time)**.

Call us Toll Free: 844-333-3903

Email us: support@emeraldintegrations.com

Returns

30-Day Money-Back Guarantee

At Emerald Integrations, we want to make sure that you are completely satisfied. If for some reason you aren't happy with an item on your order and want to return it, we make returns and refunds extremely simple.

Any complete, like-new item returned within 30-days can be returned for a full refund less the original cost of shipping. All items or packages shipped free of charge will be subject to a \$15.00 shipping fee. If returned items are not in like-new condition, then Emerald Integrations may refuse a return or charge a restocking fee of 10% - 20%. Items not in like-new condition include, but are not limited to: items missing original item packaging, opened software or media items, used items, installed items, abused or physically damaged items, items missing parts, items damaged due to improper return shipping, items with a different serial number or defaced serial number, pre-cut wire, made-to-order items and special order items. All returns must be shipped back in a shipping carton, items cannot be shipped back in product boxes. Should you have any questions about our return procedure, please don't hesitate to contact us.

Return Disclaimer

Any unauthorized, improperly packaged, or non-insured packages will be returned to sender. Items that show signs of wear or have been, scratched, altered, or damaged in any way cannot be accepted for return.

Warranty

Emerald Integrations understands that there are minor chances that electronics can fail and defects happen, in the event that this occurs, Emerald Integrations is here to help you quickly resolve your defect for a full year of 1-Year Warranty Coverage. Unlike others who push you to a manufacturer service center that can be slow and unresponsive, we're here to help with the repair or replacement you need. To begin the process, follow the instructions on the returns page at www.emeraldintegrations.com/returns.

The terms of the warranty are subject to the specific manufacturer and all expressed and implied warranties are provided solely by the manufacturer. Every item approved for a warranty claim is inspected by our team of qualified experts and professionally tested.

Emerald Integrations is a retail and wholesale distributor of vehicle electronic components, specializing in car safety. Emerald tests each product individually to ensure optimal performance and is NOT responsible for any negligence or damages caused by the installation process. Should a customer request assistance in finding an installer, Emerald holds no liability for any installers recommended by Emerald, it's employees or affiliates.